

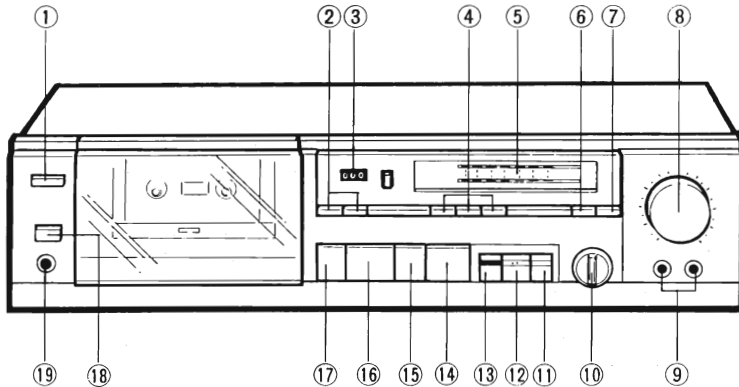

HITACHI

SERVICE MANUAL

TK
No. 1581E
D-E37
(U,C,FS,BS,AU,W)

CONTENTS

Specifications	2
Disassembly	2
Adjustment	3
Inspection of mechanism	4
Lubrications	4
Schematic diagram	5
Circuit board diagram	7
Wiring diagram	9
Circuit board diagram	11
Replacement parts list	12
Exploded view (Mechanism-FL-12C)	13
Exploded view (Cabinet)	15

KEY TO ILLUSTRATIONS

- | | |
|-----------------------------|-----------------------|
| ① POWER (MAINS) SWITCH | ⑪ REC. MUTE BUTTON |
| ② TIMER SWITCHES | ⑫ PAUSE BUTTON |
| ③ TAPE COUNTER | ⑬ RECORD BUTTON |
| ④ TAPE SELECT SWITCHES | ⑭ STOP BUTTON |
| ⑤ DIGITAL PEAK METER | ⑮ FAST FORWARD BUTTON |
| ⑥ DOLBY NR SWITCH | ⑯ PLAYBACK BUTTON |
| ⑦ INPUT SELECT SWITCH | ⑰ REWIND BUTTON |
| ⑧ RECORDING LEVEL CONTROL | ⑱ EJECT BUTTON |
| ⑨ MICROPHONE SOCKETS | ⑲ HEADPHONE SOCKET |
| ⑩ RECORDING BALANCE CONTROL | |

SAFETY PRECAUTION

The following precautions should be observed when servicing.

- Since many parts in the unit have special safety-related characteristics, always use genuine Hitachi's replacement parts. Especially critical parts in the power circuit block should not be replaced with other makes. Critical parts are marked with  in the schematic diagram, and circuit board diagram.
- Before returning a repaired unit to the customer, the service technician must thoroughly test the unit to ascertain that it is completely safe to operate without danger of electrical shock.

SPECIFICATIONS AND PARTS ARE SUBJECT TO CHANGE FOR IMPROVEMENT

STEREO CASSETTE TAPE DECK

June 1981
TOKAI WORKS

SPECIFICATIONS

Semi-conductors:		Dolby NR ON:	66 dB (Weighted A, Reference 3% THD Metal Tape)
ICs:	6		65 dB*
Transistors:	39 (U, C)	Wow and Flutter:	0.04% (WRMS)
	41 (FS, BS, AU, W)		0.13%*
Diodes:	17 (U, C)	Input Sensitivity and Impedance:	
	18 (FS, BS, AU, W)	Microphone:	0.42 mV, 300 ohms~5k ohms
Varistor:	1	Line in:	100 mV, 50k ohms or more
LEDs:	17	DIN (Record/Playback):	0.3 mV, 3k ohms (FS, BS, AU, W)
Track System:	4 track 2 channel stereo	Output Level:	500 mV
Tape:	Cassette tape (C-30, 60, 90)	Output Load Impedance:	
Tape Speed:	4.75 cm/s	Line out:	50k ohms or more
Recording System and		DIN (Record/Playback):	50k ohms or more (FS, BS, AU, W)
Bias Frequency:	AC bias, 85 kHz	Headphone:	8 ohms~2k ohms
Erasing System:	AC erase	Distortion:	1.0% (1 kHz, 160 nwb/m)
Erase Ratio:	65 dB or more (at 1 kHz)	Crosstalk:	60 dB or more (at 1 kHz)
Frequency Response:		Channel Separation:	30 dB or more (at 1 kHz)
NOR:	20 Hz ~16 kHz	Power Supply:	AC 120V, 60 Hz (U, C)
	30 Hz ~15 kHz (± 3 dB)		AC 100-110V/115-127V/ 200-220V/230-250V, 50/60 Hz (W)
	30 Hz ~15 kHz*		AC 220V, 50 Hz (FS)
CrO ₂ :	20 Hz ~17 kHz		AC 240V, 50 Hz (BS, AU)
	30 Hz ~16 kHz (± 3 dB)	Power Consumption:	15W (U, C, FS, W)
	30 Hz ~16 kHz*		16W (BS, AU)
METAL:	20 Hz ~17 kHz	Dimensions:	110 (H) x 435 (W) x 227 (D) mm
	30 Hz ~16 kHz (± 3 dB)	Weight:	4 kg
	30 Hz ~16 kHz*	Motor:	Electronically controlled DC motor
S/N (Signal to Noise Ratio):		Heads:	Metal SL Record/playback head Multi-gap ferrite Erase head
Dolby NR OFF:	58 dB (Weighted A, Reference 3% THD Metal Tape)		
	57 dB*		

* According to DIN 45 500.

DISASSEMBLY

1. Cassette door

Depress the eject button to open the cassette holder.

Remove (A) (two) nylon rivets and lift up the cassette door to remove it.

2. Upper cover

Remove (B) (two) screws.

3. Bottom cover

Remove (C) (one) screw.

4. Front panel

- 1) Remove Recording balance knob.
- 2) Remove (D), (E) and (F) (seven) screws.

5. Cassette chassis

Remove (G) (two) screws.

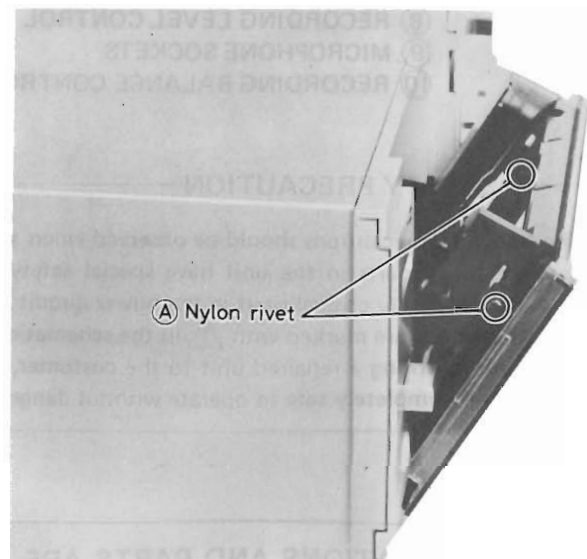

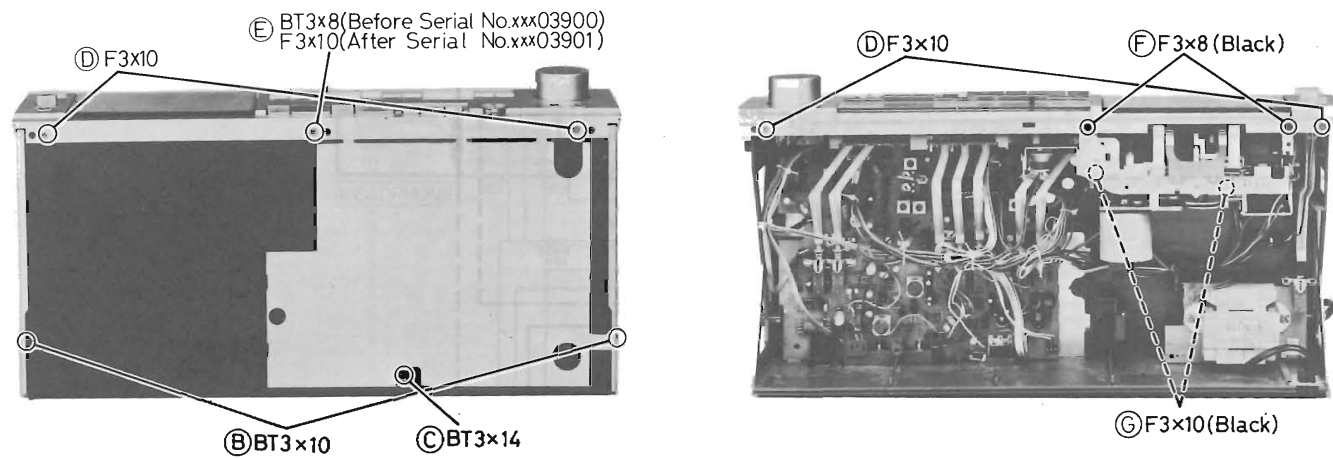

ADJUSTMENT

Perform the following adjustments in the sequence stated after cleaning the head, pressure roller and capstan with a head cleaning stick moisted in alcohol. Also, unless specially indicated otherwise, set the switches and controls to the positions indicated in the table.

Symbol No.	Switches and Controls	Position	Symbol No.	Switches and Controls	Position
S1	Input select switch	LINE	RV1	Recording level control	Max.
S2	Dolby NR switch	OFF	RV2	Recording balance control	Center
S3	Tape select switch	NORMAL			

*According to DIN 45 500

Item	Adjustments	Measuring Instrument and Connection			Check Tape	Mode	Adjusted Position	Adjusted Value	Remarks
		Measuring Instrument	Input Terminal	Output Terminal					
1	Tape speed	● Frequency counter	—	LINE OUT	MTT-111, 3000 Hz (3150 Hz*)	Playback	Semi-Variable resistor in the motor	3000 Hz +30 Hz -10 (3150 Hz*)	See Note 1
2	Head azimuth	● VTVM	—	LINE OUT	MTT-316, 12.5 kHz	Playback	Azimuth adjusting screw	Output Max.	See Note 2
3	Playback gain	● VTVM	—	IC2L, R Pin ⑧	MTT-150, 400 Hz, 20m Maxwell	Playback	RT1L, R	580 mV	See Note 3
4	Bias current	Set RT2L, R to the center.							
		● Audio oscillator (1.2kHz/12kHz, 0 dB-20 dB) ● Attenuator ● VTVM	LINE IN	LINE OUT	Hitachi ER tape	Record/playback	RT3L, R	Output difference within 1 dB	See Note 4
5	Record level	● Audio oscillator (400 Hz) ● VTVM	LINE IN	LINE OUT	Hitachi ER tape	Record/playback	RT2L, R	0 dB-3 dB	See Note 5

Note:

- Adjust within 30 sec. after heat-running for more than 20 minutes.
- When the maximum values of both channels are different, tune to the maximum value of the L channel. In this case, the difference between the maximum values of both channels should be within 2 dB.
- Playback a test tape (MTT-150, 400 Hz 20m Maxwell) and adjust RT1L, R so that the level of IC2L, R pin ⑧ becomes 580 mV.
- 1) Set RT2L, R to the center.
2) Feed a 1.2 kHz signal to the LINE IN jacks in the recording mode and adjust the audio oscillator output so that the digital peak meter indicates 0 dB. Then, adjust the attenuator to lower the output level by 20 dB.

- Record the signal on Hitachi ER tape with the conditions of item 2), then continue to record with the audio oscillator frequency set to 12 kHz.
- Playback the recorded signal and adjust RT3L, R so that the output level difference between two frequencies is within 1 dB measured at the LINE OUT jacks.
- 1) Feed a 400 Hz signal to the LINE IN jacks in the recording mode and adjust the audio oscillator output so that the digital peak meter indicates 0 dB-3 dB.
2) Record the signal on Hitachi ER tape with the conditions of item 1).
3) Playback the recorded signal and adjust RT2L, R so that the digital peak meter indicates 0 dB-3 dB.

INSPECTION OF MECHANISM

Check Item		Reference Value	Remarks
1	Pressure of pressure roller	200 to 270 gr	Note 1
2	Torque	Take-up	35 to 65 gr-cm Measure in playback mode
		Fast forward	75 to 110 gr-cm Measure in fast forward mode
		Rewind	75 to 110 gr-cm Measure in rewind mode
3	Back-tension	Take-up turntable	1.7 to 4.5 gr-cm Measure in playback mode
		Supply turntable	1.7 to 4.5 gr-cm Measure in playback mode
4	Brake-torque	Take-up turntable	50 to 100 gr-cm Measure in stop mode
		Supply turntable	

Note 1. Pressure of pressure roller

Set this unit in the playback mode and press the pressure roller in the direction of the arrow using a fan type tension gauge, and measure the pressure when the pressure roller is released from the capstan.

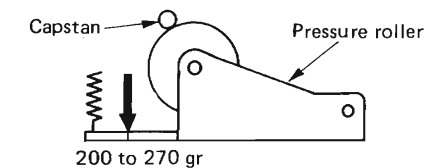

LUBRICATIONS

Lubricate one or two drops of oil to rotating point or lubricate grease to sliding point.
Lubricate the respective parts listed once every 1000 hours or once a year under normal conditions of use.
Avoid oiling them excessively, or rotation may become irregular because of oil splashes.

	Lubrication	Oil or Grease
Rotary section	Metal and metal	Pan motor oil (10W-40)
	Mold and metal	Sonic slider oil (#1600)
Sliding section	Metal and metal	Hitasol (MO-138)
	Mold and mold	White grease (FL-LUBE-A)
	Mold and metal	
Spring resonance prevention		Froil (GB-TS-1)

SCHEMATIC DIAGRAM

- Q2L 25C1845 SWITCHING
- Q3L 25C1845 SWITCHING
- Q4L 25C1740S SWITCHING
- Q1L 25C1740LINE,S MIC/DIN AMP
- Q5L 25C1740LINE,S PRE AMP.
- Q6L 25C1740LINE,S PRE AMP.
- Q7L 25C2320E,F SWITCHING
- IC1 HD14066BP REC/PB.SWITCHING
- ZD4 HZ 9B VOLTAGE STAB.
- Q8L 25C2320E,F SWITCHING
- Q13L 25C202IS REC. AMP
- IC2L TA7629P DOLBY NR
- Q12L 25D467BC SWITCHING
- D4 IS 2473 PROT.
- Q9L 25D467BC SWITCHING
- Q10 25C2320E,F SWITCHING
- ZD1 RD2R7E LEVEL SHIFT
- Q11L 25C2320E,F HEADPHONE AMP
- Q20,D21 25C2320E,F SWITCHING

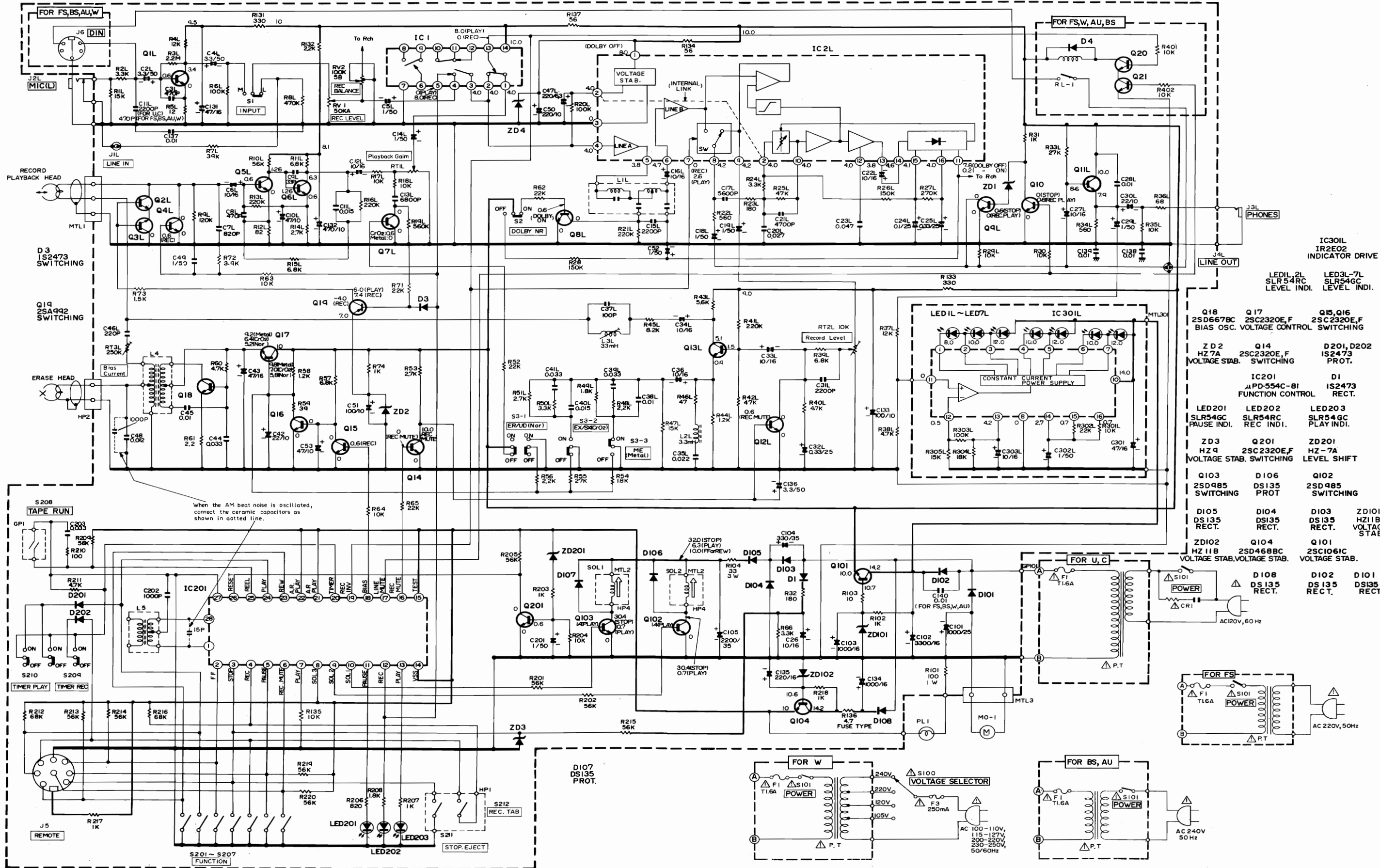

When the AM beat noise is oscillated, connect the ceramic capacitors as shown in dotted line.

- IC301L IR2E02 INDICATOR DRIVE
- LED1L,2L SLR54RC LEVEL INDI.
- LED3L-7L SLR54GC LEVEL INDI.
- Q18 25D667BC BIAS OSC.
- Q17 25C2320E,F VOLTAGE CONTROL
- Q15,Q16 25C2320E,F SWITCHING
- ZD2 HZ 7A VOLTAGE STAB.
- Q14 25C2320E,F SWITCHING
- D201,D202 IS2473 PROT.
- IC201 μ PD-554C-81 FUNCTION CONTROL
- D1 IS2473 RECT.
- LED201 SLR54GC PAUSE INDI.
- LED202 SLR54RC REC INDI.
- LED203 SLR54GC PLAY INDI.
- ZD3 HZ 9 VOLTAGE STAB.
- Q201 25C2320E,F SWITCHING
- ZD201 HZ-7A LEVEL SHIFT
- Q103 25D485 SWITCHING
- D106 DS135 PROT.
- Q102 25D485 SWITCHING
- D105 DS135 RECT.
- D104 DS135 RECT.
- D103 DS135 RECT.
- ZD101 HZ11B VOLTAGE STAB.
- ZD102 HZ 11B VOLTAGE STAB.
- Q104 25D468BC VOLTAGE STAB.
- Q101 25C1061C VOLTAGE STAB.
- D108 DS135 RECT.
- D102 DS135 RECT.
- D101 DS135 RECT.

CIRCUIT BOARD DIAGRAM

Note

1. Voltage measured at base of chassis with minimum volume control and no signal.
2. Nomenclature of Resistors and Capacitors.

Circuit No.	
Value	No indicated Ω(Ohm) M : 1000 kΩ
Tolerance	No indicated ±5% K : ±10% M : ±20%
Wattage	No indicated ¼W
Sort	No indicated Carbon film RC : Composition RW : Wire wound RS : Oxide metal film RN : Fixed metal film

Circuit No.	
Value	No indicated μF P : PF
Tolerance	No indicated ±10% J : ± 5% M : ±20% Z : +80% -20% D : ±0.5pF C : ±0.25pF
Sort	Ceramic Electrolitic Mylar Polyester Styrol
Voltage	No indicated 50WV

3. Be sure to make your orders of resistors and capacitors with value, voltage, tolerance and sort.
4. When replacing capacitors marked with *, use specified ones stated on parts list since required temperature characteristics.

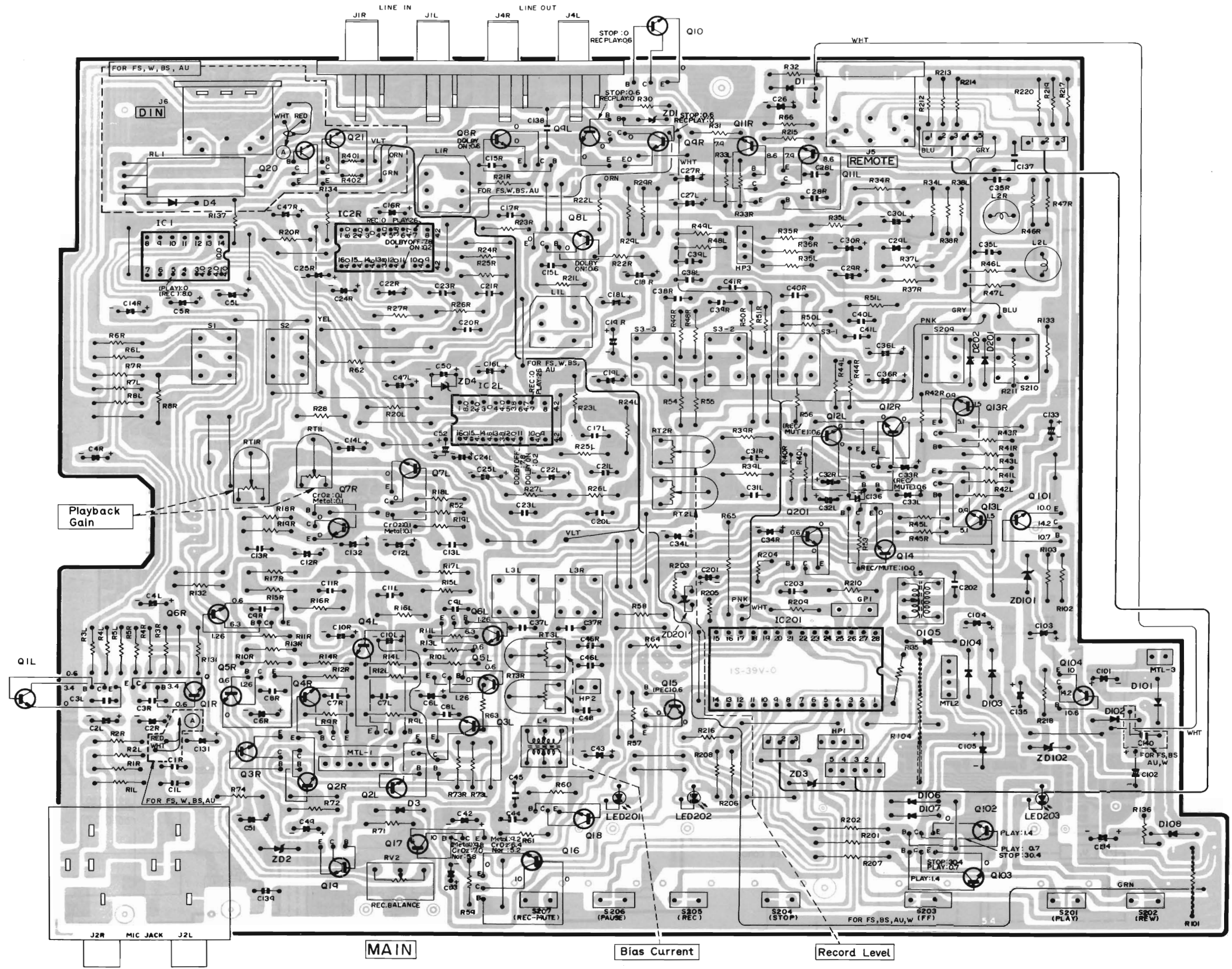

WIRING DIAGRAM

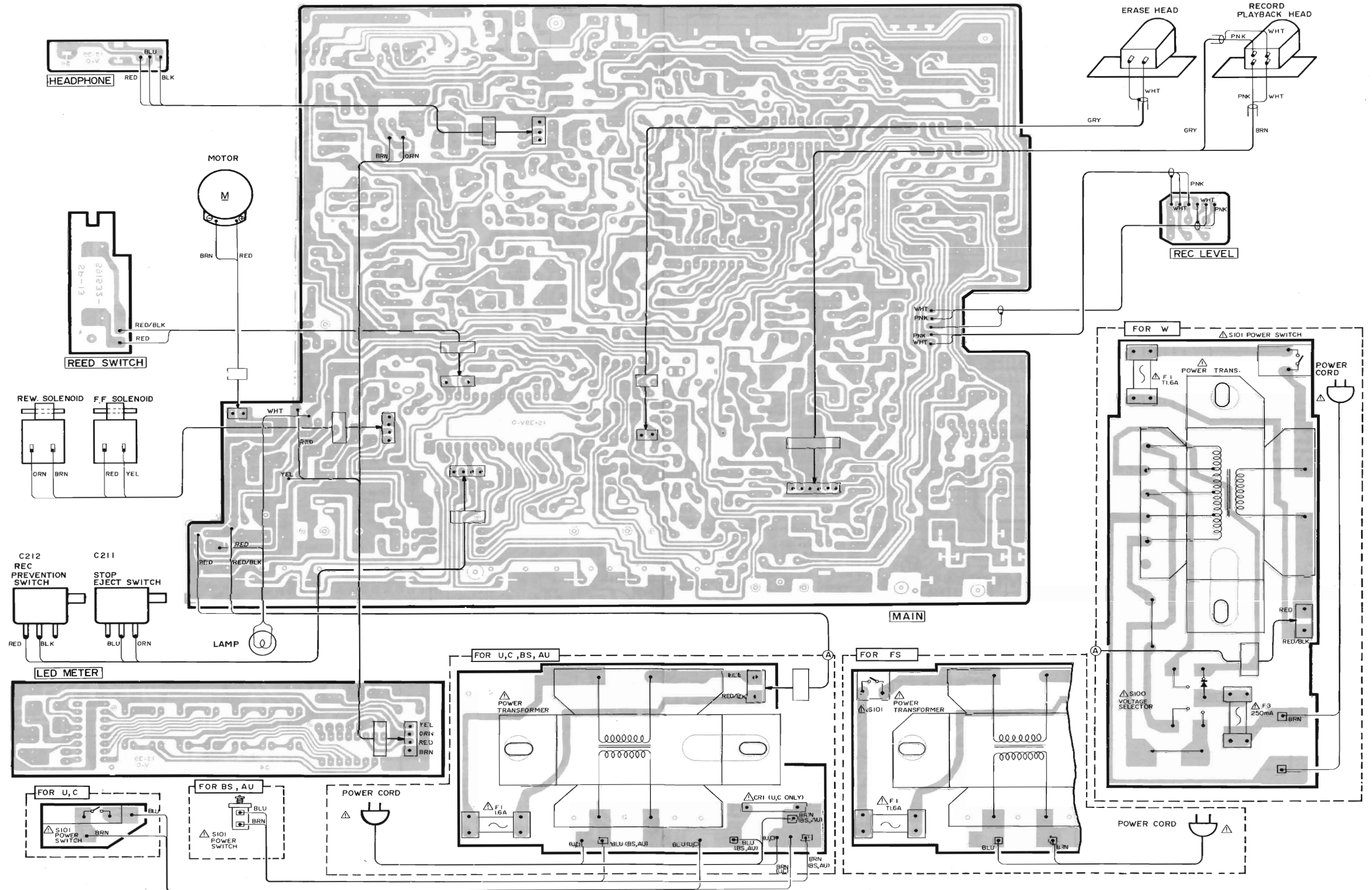

CIRCUIT BOARD DIAGRAM

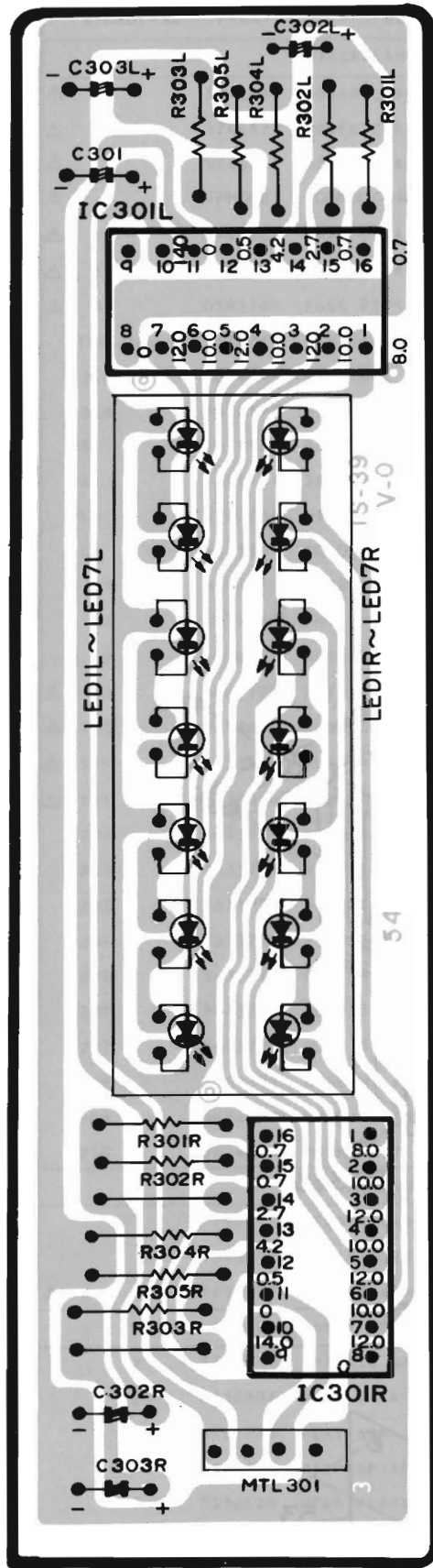

LED METER

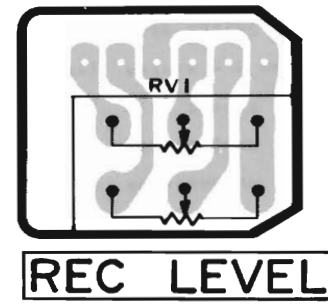

REC LEVEL

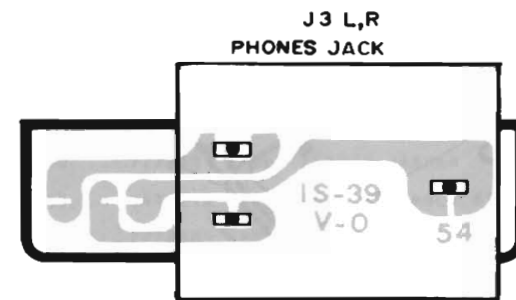

HEADPHONE

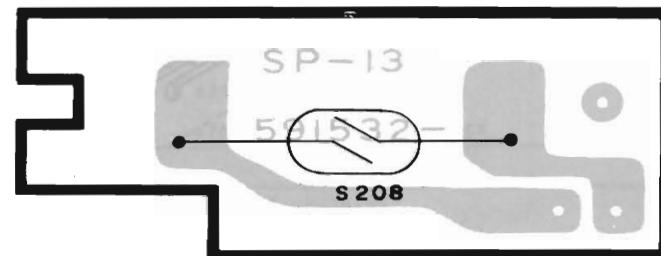

REED SWITCH

REPLACEMENT PARTS LIST

SYMBOL-NO	P-NO	DESCRIPTION	SYMBOL-NO	P-NO	DESCRIPTION
CAPACITORS					
△ CR1	0219902	CR PACK 120 OHM 0.0033MF 450V (U)	Q 2LR	5323031	TRANSISTOR 2SC1845EF
△ CR1	0219907	CR PACK (C)	Q 3LR	5323031	TRANSISTOR 2SC1845EF
RESISTORS					
RT1LR	5007478	SEMI VARIABLE 20K OHM	Q 4LR	5321296	TRANSISTOR 2SC1740LN-RS
RT2LR	5007477	SEMI VARIABLE 10K OHM	Q 5LR	5321298	TRANSISTOR 2SC1740LN-SE
RT3LR	5007482	SEMI VARIABLE 250K OHM	Q 6LR	5321296	TRANSISTOR 2SC1740LN-RS
RV1	5000615	VARIABLE RESISTOR 50K OHM(A)	Q 7LR	5323013	TRANSISTOR 2SC2603EF
RV2	5000853	VARIABLE RESISTOR 100K OHM(B)	Q 8LR	5323013	TRANSISTOR 2SC2603EF
R136	0170473	FUSE RESISTOR 4.7 OHM+-5%	Q 9LR	5321194	TRANSISTOR 2SD467BC
SEMI-CONDUCTORS					
D 1	5330573	DIODE 1S2473	Q 10	5323013	TRANSISTOR 2SC2603EF
D 3	5330573	DIODE 1S2473	Q 11LR	5323013	TRANSISTOR 2SC2603EF
D 4	5330573	DIODE 1S2473 (FS, BS, AU, W)	Q 12LR	5321194	TRANSISTOR 2SD467BC
D101	5331671	DIODE DS135D-FA3	Q 13LR	5321662	TRANSISTOR 2SC2021S
D102	5331671	DIODE DS135D-FA3	Q 14	5323013	TRANSISTOR 2SC2603EF
D103	5331671	DIODE DS135D-FA3	Q 15	5323013	TRANSISTOR 2SC2603EF
D104	5331671	DIODE DS135D-FA3	Q 16	5323013	TRANSISTOR 2SC2603EF
D105	5331671	DIODE DS135D-FA3	Q 17	5323013	TRANSISTOR 2SC2603EF
D106	5331671	DIODE DS135D-FA3	Q 18	5322651	TRANSISTOR 2SD667C
D107	5331671	DIODE DS135D-FA3	Q 19	5323041	TRANSISTOR 2SA992FE
D108	5331671	DIODE DS135D-FA3	Q 20	5323013	TRANSISTOR 2SC2603EF (FS, BS, AU, W)
D201	5330573	DIODE 1S2473	Q 21	5323013	TRANSISTOR 2SC2603EF (FS, BS, AU, W)
D202	5330573	DIODE 1S2473	Q101	5321301	TRANSISTOR 2SC1061
IC 1	5365491	IC HD14066BP	Q102	5322671	TRANSISTOR 2SD985
IC 2LR	5352691	IC HA12413	Q103	5322671	TRANSISTOR 2SD985
IC201	5359725	IC MPD554-81	Q104	5321212	TRANSISTOR SILICON 2SD468B
IC301LR	5365501	IC IR-2E02	Q201	5323013	TRANSISTOR 2SC2603EF
LED 1LR	5380482	LED SLR54RC	ZD 1	5330847	ZENER DIODE RD2.7E-B2
LED 2LR	5380482	LED SLR54RC	ZD 2	5330311	ZENER DIODE SILICON HZ7A
LED 3LR	5380481	LED SLR54GC	ZD 3	5330323	ZENER DIODE HZ9C
LED 4LR	5380481	LED SLR54GC	ZD101	5330555	ZENER DIODE HZ11B2
LED 5LR	5380481	LED SLR54GC	ZD102	5330555	ZENER DIODE HZ11B2
LED 6LR	5380481	LED SLR54GC	ZD201	5330311	ZENER DIODE SILICON HZ7A
LED 7LR	5380481	LED SLR54GC	COILS		
LED201	5380481	LED SLR54GC	L1LR	5161664	DOLBY FILTER
LED202	5380482	LED SLR54RC	L2LR	5150364	CHOKE COIL 3.3 MH
LED203	5380481	LED SLR54GC	L3LR	5260215	TRAP COIL 33MH
Q 1LR	5321298	TRANSISTOR 2SC1740LN-SE	L4	5260461	BIAS OSCILLATOR COIL
			L5	5132113	CHOKE COIL



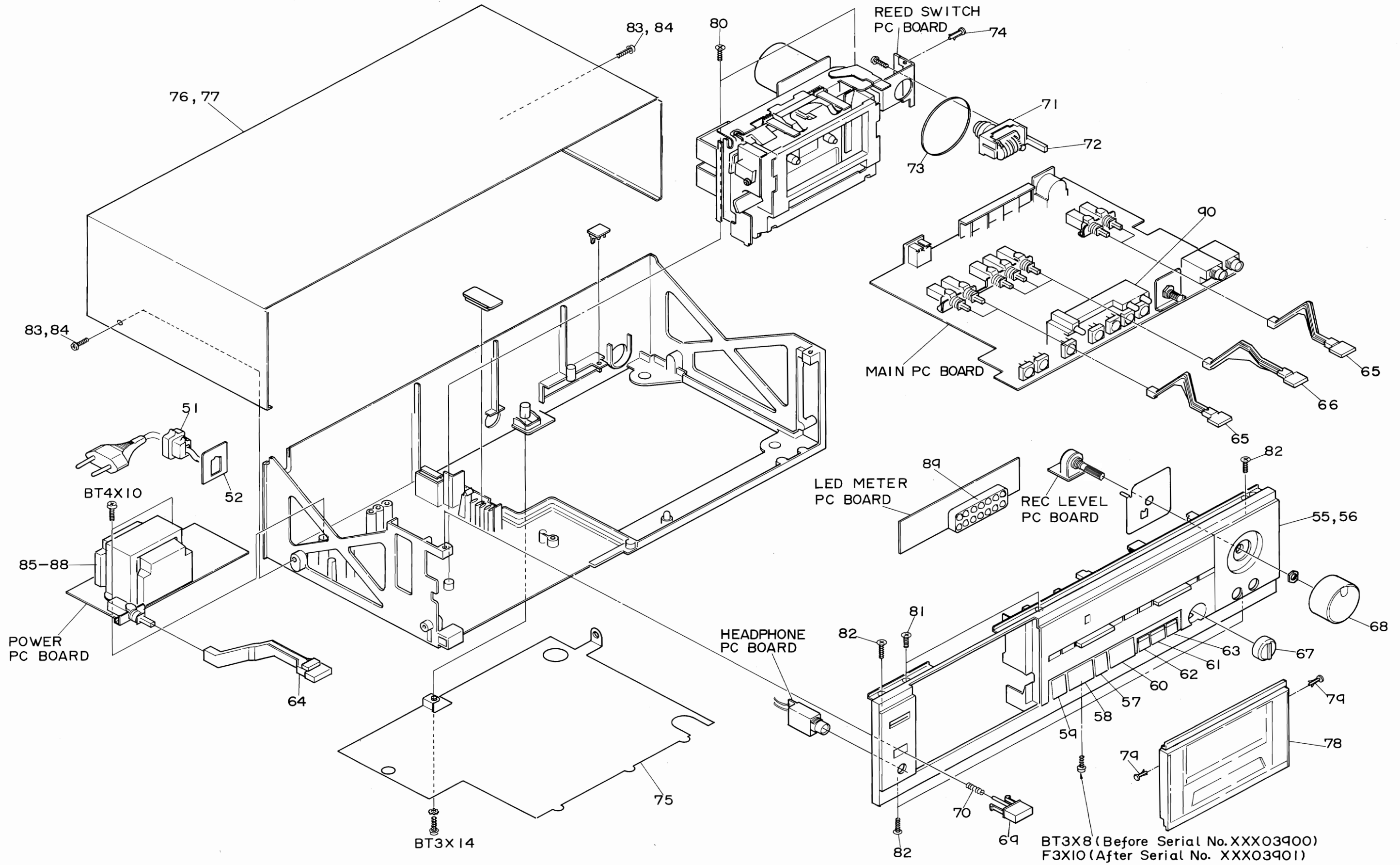



EXPLODED VIEW (Cabinet)



REPLACEMENT PARTS LIST

SYMBOL-NO	P-NO	DESCRIPTION	SYMBOL-NO	P-NO	DESCRIPTION
MISCELLANEOUS			10	7775211	SPECIAL SCREW
△	5746443	POWER CORD (U,C)	11	6321733	HEAD SPRING C
△	5746571	POWER CORD (AU)	12	7771441	WASHER - 2 MMD
△	5746661	POWER CORD (W,FS)	13	7768181	HEAD SPACER
△	5746342	POWER CORD (BS)	14	7771442	WASHER-2MMD
△ F 1	5721061	FUSE 1.6A (FS,BS,AU,W)	15	7771444	WASHER-2MMD
△ F 1	5721161	FUSE 1.6A (U,C)	16	6581042	RUBBER FOR RECORD PREVENTION
△ F 3	0591160	FUSE 250MA (W)	17	6302375	SPRING
J1LR, J4LR	5676261	PIN JACK ASSEMBLY (LINE IN, LINE OUT)	18	6761741	REWIND ARM
J2LR	5679742	MIC JACK	19	6761707	TAKE UP IDLER ASSEMBLY
J3LR	5674193	HEADPHONE JACK	20	6320578	SPRING FOR TAKE UP IDLER
J5	5677131	8P DIN SOCKET (REMOTE)	21	6990651	INSULATION PLATE FOR HEAD
J6	5651141	5P DIN SOCKET (FS,BS,AU,W)	22	7330581	PRESSURE ROLLER ARM ASSEMBLY
PL1	5762036	PILOT LAMP	23	6301361	SPRING
RL1	5641141	REED RELAY (FS,BS,AU,W)	24	7330663	EJECT HOLDER ASSEMBLY
S 1	5634412	PUSH SWITCH (INPUT)	25	5633361	PUSH SWITCH
S 2	5634412	PUSH SWITCH (DOLBY NR)	26	0671310	DT SCREW-2.6MMDX10MM
S 3	5634413	PUSH SWITCH (TAPE SELECTOR)	27	6761814	RECORD PREVENTION ARM
△ S100	5605121	ROTARY SWITCH (VOLTAGE SELECTOR) [W]	28	6761696	REEL BASE ASSEMBLY
△ S101	5633801	PUSH SWITCH (POWER) [FS,W]	29	6414202	TURNTABLE ASSEMBLY (SUPPLY)
△ S101	5633842	PUSH SWITCH (POWER) [U,C]	30	7778185	POLY SLIDER WASHER
△ S101	5633844	PUSH SWITCH (POWER) [BS,AU]	31	6414213	TURNTABLE ASSEMBLY (TAKE UP)
S201	5633771	PUSH SWITCH (REW)	32	7778185	POLY SLIDER WASHER
S202	5633771	PUSH SWITCH (PLAY)	33	6761672	FF/REWIND ARM ASSEMBLY
S203	5633771	PUSH SWITCH (FF)	34	6761732	SELECT SLIDER
S204	5633771	PUSH SWITCH (STOP)	35	7330726	SOLENOID PLATE ASSEMBLY
S205	5633771	PUSH SWITCH (REC)	36	5642921	DC SOLENOID
S206	5633771	PUSH SWITCH (PAUSE)	37	8741404	BIND SCREW-3MMDX4MM
S207	5633771	PUSH SWITCH (REC MUTE)	38	6373751	FLYWHEEL ASSEMBLY
S208	5641431	REED RELAY (TAPE END)	39	6430932	FLYWHEEL GEAR
S209	5634413	PUSH SWITCH (TIMER REC)	40	7786623	POLY SLIDER WASHER
S210	5634413	PUSH SWITCH (TIMER PLAY)	41	7772623	SPRING
FOR ACCESSORIES			42	6534162	FLYWHEEL SUPPORT SPRING
	7790311	HEAD CLEANING STICK	43	6763431	DAMPER ASSEMBLY
	5895501	PATCH CORD	44	6301723	SPRING FOR EJECT SLIDER
△	5652291	SOCKET ADAPTER (W)	45	5576765	DC MOTOR ASSEMBLY (CAPSTAN)
FOR CASSETTE DECK ASSEMBLY (FL-12C)			46	6589591	RUBBER PLATE
1	7330718	CHASSIS BASE ASSEMBLY	47	7539007	SPECIAL SCREW
2	6430886	PLAY GEAR	48	6355193	BELT
3	6761783	PLAY ARM	49	6357301	FLYWHEEL BELT
4	6761821	PICK UP ARM	50	6768911	CASSETTE HOLDER
5	7330628	HEAD PLATE ASSEMBLY	MISCELLANEOUS		
6	5449021	RECORD PLAYBACK HEAD	△ 51	6794401	BUSHING
7	5445351	ERASE HEAD	52	7338652	BUSHING HOLDER
8	6761753	HEAD PLATE	53	6690652	CASSETTE METAL
9	7768182	SPACER	54	0678312	DT SCREW-2.6MMDX12MM (BLACK)

SYMBOL-NO	P-NO	DESCRIPTION	SYMBOL-NO	P-NO	DESCRIPTION
MISCELLANEOUS			73	6354472	COUNTER BELT
55	6224814	FRONT PANEL ASSEMBLY (U,C,BS,AU,W)	74	6714215	NYLON RIVET
56	6224815	FRONT PANEL ASSEMBLY (FS)	75	6044392	BOTTOM COVER
57	6291441	FUNCTION BUTTON (F,F)	76	6044406	UPPER COVER (FS,BS,AU,W)
58	6291451	FUNCTION BUTTON (PLAY)	77	6044407	UPPER COVER (U,C)
59	6291442	FUNCTION BUTTON (REWIND)	78	6093352	CASSETTE DOOR ASSEMBLY
60	6291461	FUNCTION BUTTON (STOP)	79	6714214	NYLON RIVET
61	6291481	FUNCTION BUTTON (PAUSE)	80	7781582	FLAT SCREW-3MMDX10MM (BLACK)
62	6054651	FUNCTION BUTTON (REC)	81	8602408	DT FLAT SCREW-3MMDX8MM (BLACK)
63	6054653	FUNCTION BUTTON (REC MUTE)	82	7781581	BT FLAT SCREW-3MMDX10MM
64	6291421	POWER KNOB ASSEMBLY	83	8699410	BT BIND HEAD SCREW-3MMDX10MM (BLACK) (U,C)
65	6054365	PUSH BUTTON ASSEMBLY (TIMER, DOLBY NR, INPUT)	84	8698410	BT BIND SCREW-3MMDX10MM (FS,BS,AU,W)
66	6054366	PUSH BUTTON ASSEMBLY (TAPE SELECTOR)	△ 85	5213012	POWER TRANSFORMER (U,C)
67	6289311	KNOB (REC BALANCE)	△ 86	5213013	POWER TRANSFORMER (FS)
68	6288182	KNOB ASSEMBLY (RECORD)	△ 87	5213014	POWER TRANSFORMER (BS,AU)
69	6054381	EJECT BUTTON ASSEMBLY	△ 88	5213015	POWER TRANSFORMER (W)
70	6303115	SPRING FOR EJECT BUTTON	89	6767421	LED SPACER
71	5559551	COUNTER	90	5659501	LED HOLDER ASSEMBLY
72	6054551	RESET BUTTON			

Type of head			
P	Pan head screw		BT Binding head tapping screw
F	Flat countersunk head screw		BL Bolt
B	Binding head screw		W Washer
T	Round head tapping screw		E "E" ring
Length (L mm)			
Diameter (D mm)			

When ordering hardware excluding stated on these lists, be sure to make your orders with type and size.



HITACHI

HITACHI SALES CORPORATION OF AMERICA

Eastern Regional Office

1200 Wall Street West, Lyndhurst, New Jersey 07071
Tel. 201-935-8980

Mid-Western Regional Office

1400 Morse Ave., Elk Grove Village, Ill. 60007
Tel. 312-593-1550

Southern Regional Office

510 Plaza Drive College Park, Georgia 30349
Tel. 404-763-0360

Western Regional Office

401 West Artesia Boulevard, Compton, California 90220
Tel. 213-537-8383

HITACHI SALES CORPORATION OF HAWAII, INC

3219 Koapaka Street, Honolulu, Hawaii 96819, U.S.A.
Tel. 808-836-3621

HITACHI SALES CORP. OF CANADA Ltd.

3300 Trans Canada Highway Pointe Claire, Quebec, H9R1B1, Canada
Tel. 514-697-9150

HITACHI SALES EUROPA GmbH

2 Hamburg 54, Kleine Bahnstraße 8, West Germany
Tel. 850 60 71-75

HITACHI SALES (U.K.) Ltd.

Hitachi House, Station Road, Hayes, Middlesex UB3 4DR, England
Tel. 01-848-8787 (Service Centre : 01-848-3551)

HITACHI SALES SCANDINAVIA AB

Rissneleden 8, Sundbyberg, Box 7138, S-172-07 Sundbyberg 7,
Sweden
Tel. 08-98 52 80

HITACHI SALES NORWAY A/S

Oerebekk 1620 Gressvik P.O. Box 46 N-1601 Fredrikstad, Norway
Tel. 032-28050

SUOMEN HITACHI OY

Box 151, SF-15100 Lahti 10, Finland
Tel. Lahti 44 241

HITACHI SALES A/S

Kuldysen 13, DK-2630 Taastrup, Denmark
Tel. 02-999200

HITACHI SALES A.G.

5600 Lenzburg, Switzerland
Tel. 064-513621

HITACHI-FRANCE (Radio-Télévision Electro-Ménager) S.A.

9, Boulevard Ney 75018, Paris, France
Tel. 201-25-00

HITACHI SALES WARENHANDELS GMBH

A-1180/Wien, Kreuzgasse 27
Tel. (0043222) 439367/8

HITACHI SALES AUSTRALIA Pty Ltd.

153 Keys Road, Moorabbin, Victoria 3189 Australia
Tel. 95-8722

HITACHI Ltd. TOKYO JAPAN

Head Office : 5-1, 1-chome, Marunouchi, Chiyoda-ku, Tokyo
Tel. Tokyo (212) 1111 (80 lines)

Cable Address : "HITACHY" TOKYO

Codes : All Codes Used